

Article number: 03554080

Description: Fluro hydraulic rod end FMA 80D

Measures

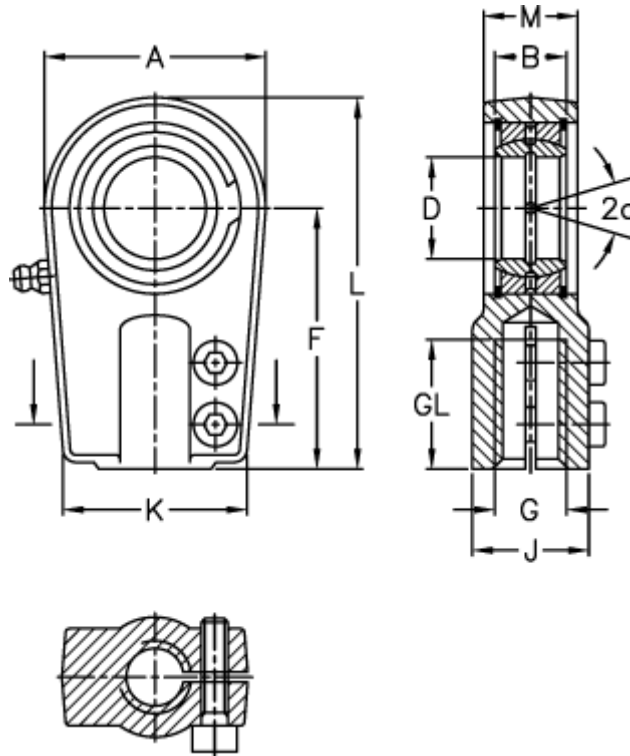

A	= 176	J	= 125
a (degrees)	= 6	K	= 158
B	= 55	L	= 305
D	= 80	M	= 60
Dynamic load C (kN)	= 570	Static load C0 (kN)	= 895
F	= 210	Torque (N m)	= 300
g	= M90x3	Weight	= 16000
GL	= 120		